

**Partner for
packaging solutions**

MF[™] Seamless belts
for vertical form fill sealers



Packaging

Seamless belts for vertical form fill sealers

Chiorino manufactures a wide range of **MF** high performing seamless belts, suitable for the form fill sealing by any packaging material (polyethylene and PVC films, paper, fabric, etc.).

Where required, a **timing belt** can be applied on the bottom surface to provide absolute synchronous drive, avoiding any risk of slippage.



TRULY ENDLESS **MF** BELTS

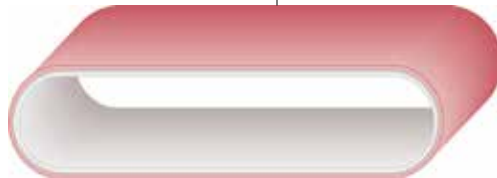

KEY FEATURES

- Total surface uniformity thanks to the seamless technology (no joint)
- High and constant surface's coefficient of friction
- High flexibility
- Absolute thickness regularity all over belt's length and width
- Perfect dimensional stability
- Precise fabrication: countersunks, grooves, slots, perforations



MF™

Chiorino high performing elastomer



- **Superb friction properties**
- **Excellent resistance to abrasion**
- **Highest creep recovery**
- **No cracking**

BENEFITS

- High production's precision thanks to the high and constant coefficient of friction
- Long service life thanks to excellent wear and tear resistance
- Suitable for high operating speed
- Time and cost saving as no lubrication is required
- Suitable for any kind of packaging

Belt constructions

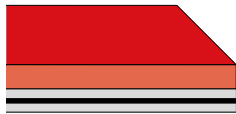
MF Chiorino seamless belts can be supplied combining different constructions and coverings.

<p>Standard coverings</p> <p> ■ L: raspberry 35 Sh.A □ HS W: white 40 Sh.A ■ R: purple red 45 Sh.A ■ B: beige 55 Sh.A </p> <p>Special coverings are available upon request.</p>			
	<p>Elastic belt (no fabric traction core)</p> <p>Two elastomer layers:</p> <ul style="list-style-type: none"> • Outer cover: high coefficient of friction; • Inner cover: hard-wearing. 	<p>Belt with polyester fabric traction core</p> <ul style="list-style-type: none"> • Outer cover: high coefficient of friction; • Polyester fabric traction core, hard-wearing and low coefficient of friction. 	<p>Rubber or polyurethane timing belt</p> <p>Two different types of timing belts can be fitted on the bottom:</p> <ul style="list-style-type: none"> • Rubber: both metric and imperial pitch; • Polyurethane: metric pitch.

Technical data

MF belts

Type	Traction core	Outer cover			Inner cover			Total thickness mm	Pull for 1% elongation N/mm	Temperature resistance	
		material	colour	Sh.A	material	color	Sh.A			min. °C	max. °C
MF R-052	---	elastomer	purple red	45	elastomer	purple red	45	5±15	0.1 ¹	-20	+100
MF R-053	---	elastomer	purple red	45	elastomer	black	65	5±15	0.1 ¹	-20	+100
MF L-300	PET	elastomer	raspberry	35	---	black	---	6±12	10.0	-20	+100
MF HS W-300	PET	elastomer	white	40	---	black	---	6±12	10.0	-20	+100
MF R-300	PET	elastomer	purple red	45	---	black	---	6±12	10.0	-20	+100
MF B-300	PET	elastomer	beige	55	---	black	---	6±12	10.0	-20	+100

MF timing belts

Type	Traction core	Outer cover			Inner cover			Max. pull for 1% elongation N/mm	Temperature resistance	
		material	color	Sh.A	material	color	Sh.A		min. °C	max. °C
MF D-G L	PET	elastomer	raspberry	35	rubber timing belt	black	90	0,4	-20	+100
MF D-G HS W	PET	elastomer	white	40	"	"	90	0,4	-20	+100
MF D-G R	PET	elastomer	purple red	45	"	"	90	0,4	-20	+100
MF D-G B	PET	elastomer	beige	50	"	"	90	0,4	-20	+100
MF D-U L	PET	elastomer	raspberry	35	polyurethane timing belt	white/transparent or yellow	90	0,4	-20	+100
MF D-U HS W	PET	elastomer	white	40	"	"	90	0,4	-20	+100
MF D-U R	PET	elastomer	purple red	45	"	"	90	0,4	-20	+100
MF D-U B	PET	elastomer	beige	50	"	"	90	0,4	-20	+100

¹ Strength in N/mm² at 10% elongation

The technical data are valid under normal environmental conditions and are subject to change without notice.

Easy to order

The wide range of **MF** seamless belts suits all the most common form fill sealers.

OEM	Belt size	Special executions								
		Smooth surface	Perforated	Perforated Oval holes	Grooved on timing side	Countersunk	Horizontal slots	Vertical slots	Diagonal slots left	Diagonal slots right
BOSCH	50T10 920 x 4.5 mm				●				●	
	50T10 920 x 4.5 mm				●					●
	50T10 920 x 4.5 mm				●		●			
	37T10 920 x 4.5 mm				●		●			
FUJI MACHINERY	40-S8M-632 x 4.0 mm		●		●					
HAYSSSEN	24 x 606 x 6.2 mm									
	24 x 708 x 6.2 mm									
	280XL094 x 6.4 mm									
	280XL044 x 6.4 mm									
ILPAK	270L 100 x 7.0 mm									
	270L 100 x 7.0 mm									
	50T10 530 x 4.0 mm				●				●	●
	50T10 720 x 4.0 mm				●				●	●
	50T10 440 x 6.4 mm									
	25T10 560 x 6.4 mm									
	50T10 720 x 4.0 mm				●			●		
	50T10 530 x 4.0 mm				●			●		
25T10 440 x 6.4 mm										
ISHIDA	255H1 50 x 3.0 mm		3 rows		●					
KLIKLOK-WOODMAN	240XL1 50 x 6 mm									
	240XL1 50 x 6 mm	●								
MATRIX PACKAGING	800-5M-25 x 4.8 mm									
PACKAGE MACHINERY	3.00" x 35.00" x .16"		3 rows							
	3.00" x 35.00" x .16"		5 rows							
PACMAC	.938" x 27.875" x .245"									
RICCIARELLI	45 x 465 x 12.00 mm									
ROVEMA	50T10 630 x 6 mm				●					
	50T10 630 x 5 mm				●	●				
	50T10 630 x 6.4 mm									
	50T10 630 x 5 mm				●	●				
	30T10 630 x 5 mm				●	●				
	29T10 630 x 6.4 mm				●					
	50T10 780 x 4.5 mm				●	●				
SANDIACRE	225L094 x 6.5 mm									
	270L098 x 4.5 mm				●				●	
	270L098 x 4.5 mm				●				●	
SIMIONATO	255L 150 x 8.0 mm									
TNA	367L 051 x 4.5 mm		●							
	367L 051 x 4.5 mm			●						
TRIANGLE PACKAGING	340XL1 78 x .08"				●				●	

Special executions

MF Chiorino seamless belts can be supplied with special executions according to customer's needs.

Diagonal slots and grooved on timing side

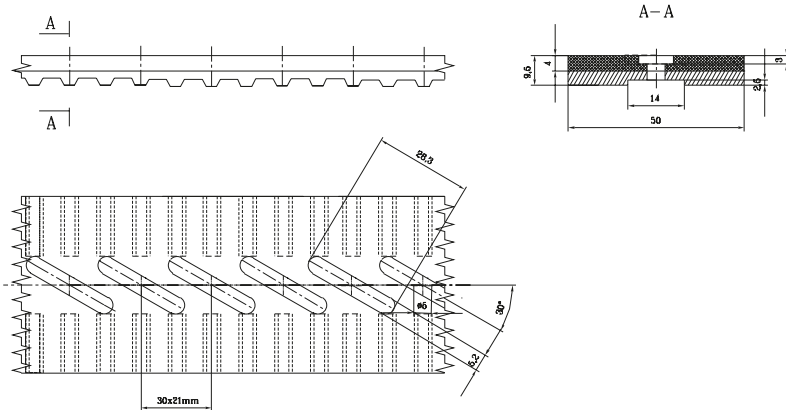

Countersunk and grooved on timing side

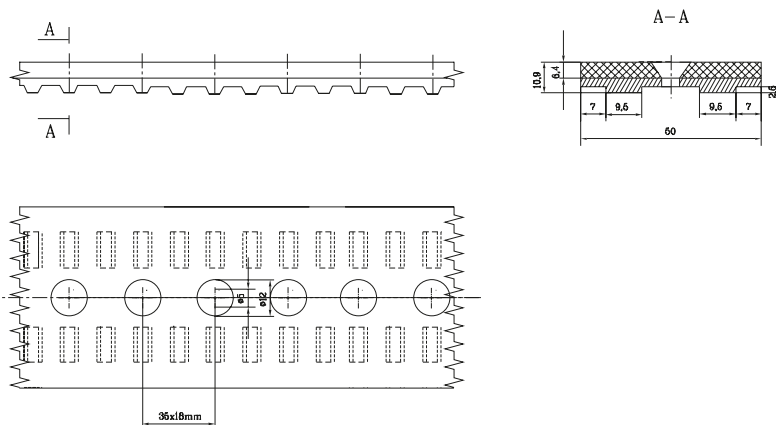

Vertical slots and grooved on timing side

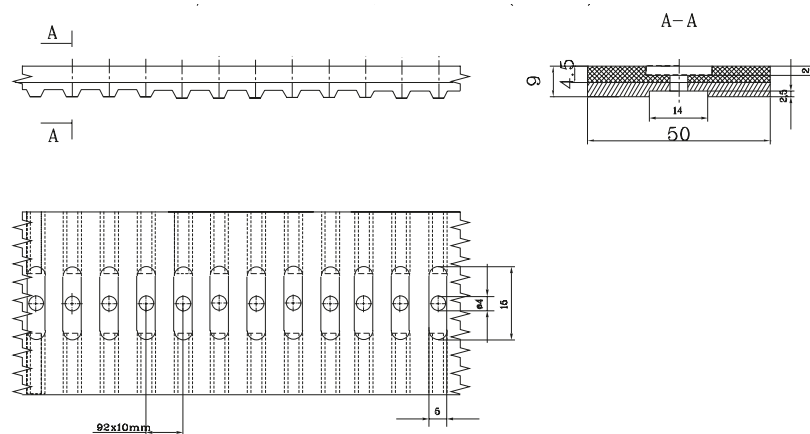

CHIORINO AFFILIATED COMPANIES

America

CHIORINO AMERICA
Newark, DE
Tel. +1-302-292-1906
info@chiorino.us
www.chiorino.us

Australia

CHIORINO AUSTRALIA - Brisbane
Tel. +61-7-3274 1900
sales@chiorino.com.au
www.chiorino.com.au

Benelux

CHIORINO BENELUX B.V. - Utrecht,
The Netherlands
Tel. +31-30-2413060
chiorino@chiorino.nl
www.chiorino.nl

Byelorussia

CHIORINO-K - Minsk
Tel. +375-17-2804578
general@chiorino.ru
www.chiorino.ru

China

CHIORINO ASIA Ltd.
Hong Kong
Tel. +852-397-10818
info@chiorino.asia
www.chiorino.asia

CHIORINO LIAISON OFFICE, Shanghai
Tel. +86-21-37831019
info@chiorino.cn
www.chiorino.cn

France

CHIORINO SAS - Lagny, Paris
Tel. +33-1-64304075
chiorino.paris@chiorino.fr
www.chiorino.fr

Germany

CHIORINO GmbH - Mainz
Tel. +49-(0)6131-55449-0
info@chiorino.de
www.chiorino.de

Hungary

CHIORINO Kft. - Szigetszentmiklós,
Budapest
Tel. +36-24-525930
mail@chiorino.hu
www.chiorino.hu

India

CHIORINO INDIA - Salcete Goa
Tel. +918-322-782454
info@chiorino.in
www.chiorino.in

Italy

CHIORINO PARMA s.r.l. - Parma
Tel. +39-0521-292236
chiorinoparma@chiorino.com

CHIORINO VENETO s.r.l. - Colle Umberto
Tel. +39-0438-430460
chiorinoveneto@chiorino.com

Poland

CHIORINO Sp. z o.o. - Bydgoszcz
Tel. +48-(0)52-3487708
chiorino@chiorino.com.pl
www.chiorino.com.pl

Portugal

CHIORINO PORTUGAL, LDA
Alfena Valongo, Porto
Tel. +35-122-9684442
geral@chiorino.pt
www.chiorino.pt

Romania

CHIORINO srl - Cluj Napoca
Tel. +40-264-432977
chiorino@chiorino.ro
www.chiorino.ro

South Africa

CHIORINO SOUTH AFRICA (PTY) LTD.
Johannesburg
Tel. +27-11-3971268
sales@chiorino.co.za
www.chiorino.com

Spain

CHIORINO IBERICA S.A. - Rubí, Barcelona
Tel. +34-93-5860480
chiorino@chiorino.es
www.chiorino.es

Switzerland

CHIORINO SCHWEIZ GmbH - Wetzikon
Tel. +41-(0)43-3116001
info@chiorino.ch
www.chiorino.ch

United Kingdom

CHIORINO U.K. Ltd. - Featherstone
Tel. +44-1977-691880
sales@chiorino.co.uk
www.chiorino.co.uk

CHIORINO DISTRIBUTORS

Albania
Argentina
Armenia
Austria
Azerbaijan
Bangladesh
Belgium
Bolivia
Bosnia-Herzegovina
Botswana
Brazil
Bulgaria
Cambodia
Canada
Chile
Colombia
Costa Rica
Croatia
Cyprus
Czech Republic
Denmark
Egypt
Estonia
Fiji
Finland
Georgia
Greece
Guatemala
Honduras
Iceland
Indonesia
Iran
Ireland
Israel
Ivory Coast
Jordan
Kazakhstan
Kenya
Kirgyzstan
Laos
Latvia
Lebanon
Lithuania
Macedonia
Malawi
Malaysia
Mexico
Moldova
Morocco
Myanmar
New Caledonia
New Zealand
Nicaragua
Pakistan
Panama
Papua New Guinea
Paraguay
Peru
Russia
Saudi Arabia
Serbia
Slovak Republic
Slovenia
South Korea
Sri Lanka
Sweden
Tadjikistan
Thailand
Turkey
Turkmenistan
Ukraine
United Arabian Emirates
Uzbekistan
Vietnam
Yemen
Zimbabwe

HEADQUARTERS AND PRODUCTION PLANTS

CHIORINO S.p.A.

Via S. Agata, 9
I-13900 Biella, Italy
Tel. +39 015 8489 1
Fax +39 015 849 61 61
chiorino@chiorino.com
www.chiorino.com

UNI EN ISO 9001:2015
UNI EN ISO 14001:2015
OHSAS 18001:2007
EMAS



ENGINEERING ADVICE
ON-SITE INSTALLATION SERVICE
AFTER SALES SUPPORT

