

CHIORINO[®]
1906

Passion for belting

Your partner for
production efficiency

Quick splice High performance belts



CHIOLINK[™]

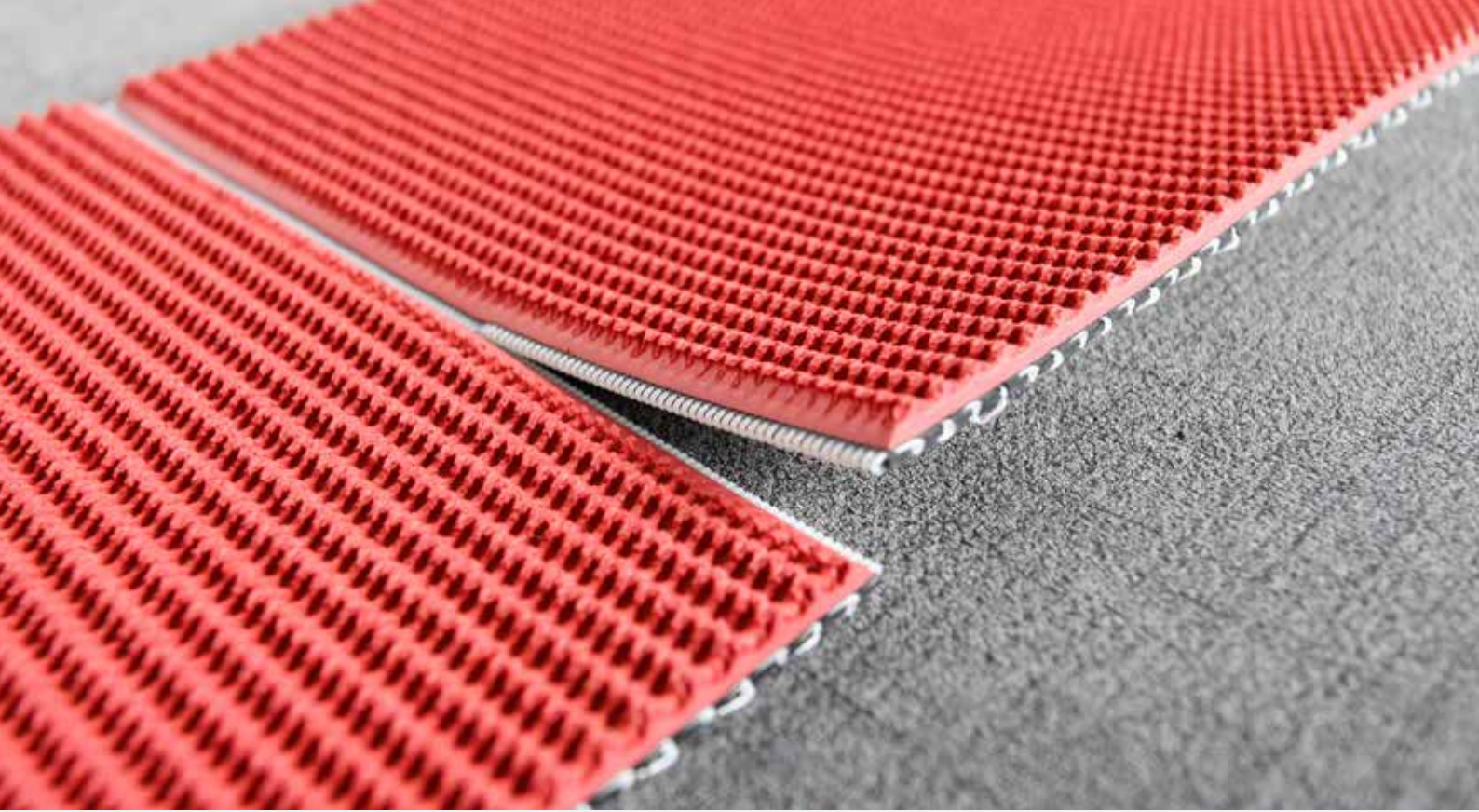

CHIOLINK™

CHIOLINK™ is a premium solution for **minimizing downtime** and **increasing production efficiency**.

Thanks to the special construction it can be made endless onsite **very quickly** and in a **unique safe way**.

CHIOLINK™ high performing elastomer covers combined with a patent pending solution for a quick & safe splicing is a **breakthrough for belting efficiency**.

Belt design

CHIOLINK™ is the combination of a spiral polyester carcass and CHIORINO superior elastomer covers. It can be easily cut at any length and made endless on site, without the use of glues.

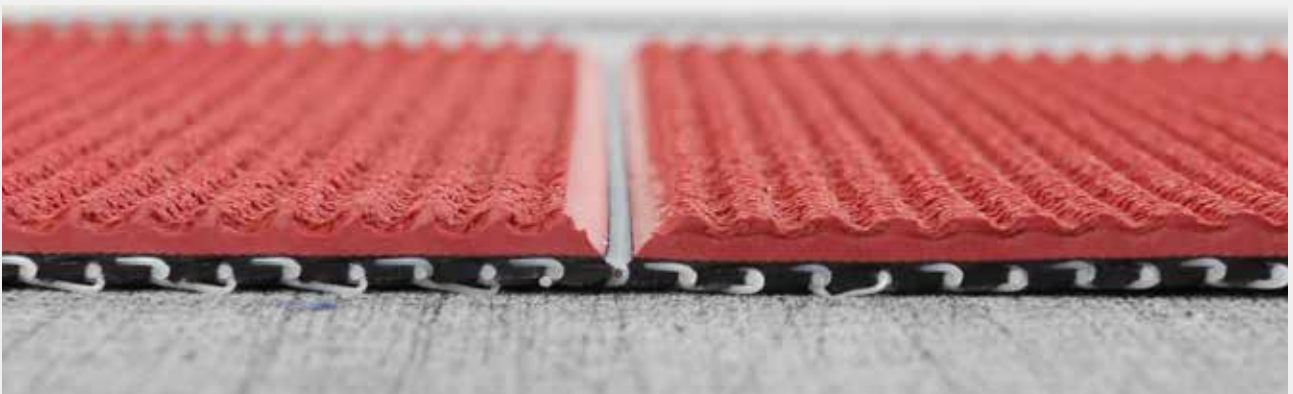

Minimize downtime

Increase efficiency



**QUICK &
SAFE
SPLICING**



**SUPERIOR
ELASTOMER
COVERS**



CHIOLINK™

Quick & Safe splicing

CHIORINO Proprietary System Patent pending



Do-it-yourself in a few minutes without specific training
Safe system
In-house installation (no external fitters needed)

- Reduced downtime
- Minimized maintenance cost
- Increased operational safety

No damages to the machine and products caused by mechanical fastener

- No waste
- Optimized Cost of Ownership

No weak points due to skived joint

- Increased production efficiency

Excellent stability

- Easy tracking

No glues

- Sustainable solution

Superior elastomer covers

CHIORINO Unique high performing solutions



Excellent resistance to abrasion

Consistent product feeding and conveying

Highest resistance to oils, inks and chemicals

Choice of covers according to different applications and processed products

- Increased efficiency
- Increased production output
- Long service life



Superior elastomers



High abrasion resistance

The unique HS® friction covers provide an excellent abrasion resistance and a uniform coefficient of friction over time.



Excellent resilience

The unique HS® elastomer offers outstanding resilience, high elasticity and crack resistance.



Long service life

Thanks to the low aging property of the cover Chiorino HS® belts provide a long service life.



Food compliance

The CHIOLINK HS food grade belts are ideal for aseptic packagings for food and pharmaceutical use.

They comply with the latest european and international food regulations.

EC 1935/2004 regulation and amendments

EC 2023/2006 regulation and amendments

DM 21/03/73 (test according to EU 10/2011)

FDA (Food and Drug Administration)



Long service life

MF® is a self-regenerating elastomer that maintains its properties during time and assures longer service life compared to traditional elastomer.



Consistent coefficient of friction

The special MF® elastomer offers high production precision thanks to the consistently high coefficient of friction.

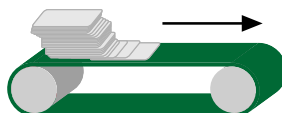

High abrasion resistance

The MF® elastomer offers excellent resistance to abrasion, oils, inks and chemicals.

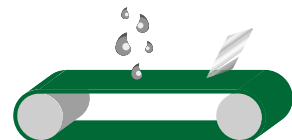

Technical data

Code	Type	Top cover			Bottom cover	Total thickness	Minimum pulley diameter	Pull for 1% elong.	Temperature resistance	
		material	texture	colour					°C	min.
NA1625	ChioLink G15 HS FL Food Grade	synthetic elastomer	FL	ivory	mesh, polyester	4.0	80	13	-20	100
NA1594	ChioLink G40 MF red	natural elastomer	FL	red	mesh, polyester	6.5	80	13	-20	100
NA1595	ChioLink G40 HS GP red	synthetic elastomer	GP	red	mesh, polyester	7.0	80	13	-20	100

The technical data are valid under normal environmental conditions and are subject to change without notice.

Surface textures



CHIOLINK™ for corrugated carton box

CHIOLINK™ is ideal for Cardboard industry, in corrugated carton box folder gluers, in particular for Stackers and Transfers. It can also be used in other sectors as wood and tyre industry.

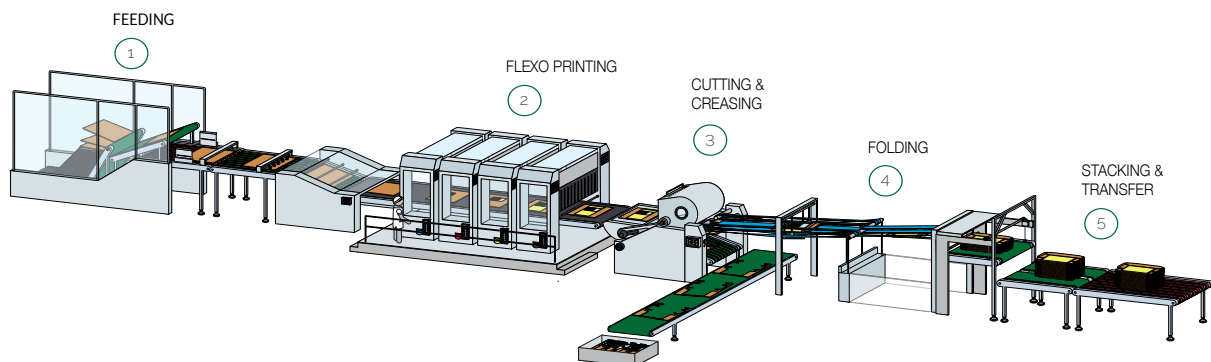

Quick & Safe

Splicing System and Tool

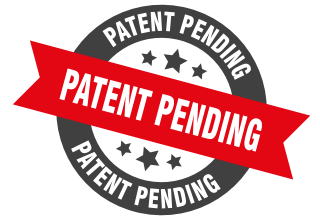

Chiorino has developed a unique and innovative system & tool that **facilitates the splicing operations**, providing benefits in terms of **Safety** for the operator and **Downtime minimization**.

The **CHIOLINK™** splicing system is a **CHIORINO PROPRIETARY TECHNOLOGY** and is **PATENT PENDING**.



CHIOLINK™
SPLICING KIT



Tools available in a handy case,
with all necessary equipment
for the Chiorino exclusive
Joining system.



CHIOLINK™

Exclusive procedure Join-it-yourself!



- No glues
- Easy to use
- High operational safety
- No need of external service
- No need of qualified training

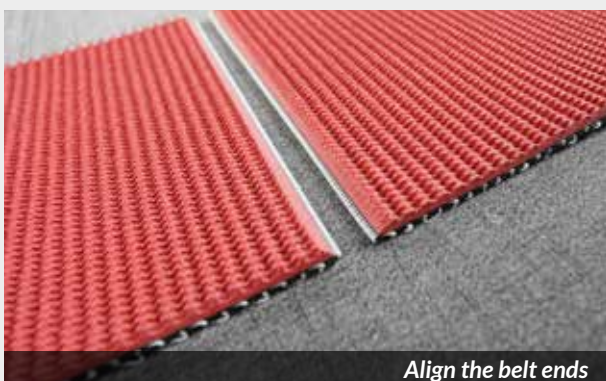

America
 CHIORINO AMERICA
 Suwanee, GA
 Tel. +1-302-292-1906
 info@chiorino.us
 www.chiorino.us

Australia
 CHIORINO AUSTRALIA
 Brisbane
 Tel. +61-7-32741900
 sales@chiorino.com.au
 www.chiorino.com.au

Benelux
 CHIORINO BENELUX B.V.
 Utrecht - Netherlands
 Tel. +31-30-2413060
 chiorino@chiorino.nl
 www.chiorino.nl

China
 CHIORINO ASIA Ltd.
 Hong Kong
 Tel. +852-397-10818
 info@chiorino.asia
 www.chiorino.asia

CHIORINO LIAISON OFFICE
 Shanghai
 Tel. +86-21-37831019
 info@chiorino.cn
 www.chiorino.cn

Czech Republic
 REKO s.r.o.
 Jaromer
 Tel. +420-491-840012
 info@reko-sro.cz
 www.reko-sro.cz

France
 CHIORINO SAS
 Lagny, Paris
 Tel. +33-1-64304075
 chiorino.paris@chiorino.fr
 www.chiorino.fr

Germany
 CHIORINO GmbH
 Mainz
 Tel. +49-(0)6131-55449-0
 info@chiorino.de
 www.chiorino.de

Hungary
 CHIORINO Kft.
 Szigetszentmiklós, Budapest
 Tel. +36-24-525930
 mail@chiorino.hu
 www.chiorino.hu

India
 CHIORINO INDIA
 Salcete Goa
 Tel. +918-322-782454
 info@chiorino.in
 www.chiorino.in

Italy
 CHIORINO PARMA s.r.l. - Parma
 Tel. +39-0521-292236
 chiorinoparma@chiorino.com

CHIORINO VENETO s.r.l. - Colle Umberto (TV)
 Tel. +39-0438-430460
 chiorinoveneto@chiorino.com

Poland
 CHIORINO Sp. z o.o.
 Bydgoszcz
 Tel. +48-(0)52-3487708
 chiorino@chiorino.com.pl
 www.chiorino.com.pl

Portugal
 CHIORINO PORTUGAL, LDA
 Alfena Valongo, Porto
 Tel. +351-229684442
 geral@chiorino.pt
 www.chiorino.pt

Romania
 CHIORINO srl
 Sannicoara, Jud.Cluj Napoca
 Tel. +40-264-432977
 chiorino@chiorino.ro
 www.chiorino.ro

Slovakia
 CHIORINO SLOVAKIA s.r.o.
 Nové Zámky
 Tel. +421-910-486654
 info@chiorino.sk
 www.chiorino.sk

South Africa
 CHIORINO SOUTH AFRICA (PTY) LTD.
 Johannesburg
 Tel. +27-11-3971268
 sales@chiorino.co.za
 www.chiorino.com

Spain
 CHIORINO IBERICA S.A.
 Rubí, Barcelona
 Tel. +34-93-5860480
 chiorino@chiorino.es
 www.chiorino.es

Switzerland
 CHIORINO SCHWEIZ GmbH
 Wetzikon
 Tel. +41-(0)43-3116001
 info@chiorino.ch
 www.chiorino.ch

Ukraine
 CHIORINO UKRAINE LLC
 Poltava region, Shcherbani village
 Tel. +38-050806560
 office@chiorino.com.ua
 chiorino.com.ua

United Kingdom
 CHIORINO U.K. Ltd.
 Glasshoughton
 Tel. +44-1977-691880
 sales@chiorino.co.uk
 www.chiorino.co.uk

Albania
 Argentina
 Armenia
 Austria
 Azerbaijan
 Bangladesh
 Belgium
 Bolivia
 Bosnia-Herzegovina
 Botswana
 Brazil
 Bulgaria
 Byelorussia
 Cambodia
 Canada
 Chile
 Colombia
 Costa Rica
 Croatia
 Cyprus
 Denmark
 Egypt
 Estland
 Fiji
 Finland
 Georgia
 Greece
 Guatemala
 Honduras
 Iceland
 Indonesia
 Iran
 Ireland
 Israel
 Ivory Coast
 Jordan
 Kazakhstan
 Kenya
 Kirgystan
 Korea
 Laos
 Latvia
 Lebanon
 Lithuania
 Macedonia
 Malawi
 Malaysia
 Mexico
 Moldova
 Morocco
 Myanmar
 New Caledonia
 New Zealand
 Nicaragua
 Norway
 Pakistan
 Panama
 Papua New Guinea
 Paraguay
 Peru
 Russia
 Saudi Arabia
 Serbia
 Slovenia
 South Korea
 Sri Lanka
 Sweden
 Tadjikistan
 Taiwan
 Thailand
 Turkey
 Turkmenistan
 United Arab Emirates
 Uzbekistan
 Vietnam
 Yemen
 Zimbabwe

**HEADQUARTERS
 AND PRODUCTION PLANTS**

CHIORINO S.p.A.
 Via S. Agata, 9
 I-13900 Biella, Italy
 Tel. +39 015 8489 1
 Fax +39 015 8489 161
 chiorino@chiorino.com
 www.chiorino.com

ENGINEERING ADVICE
 ON-SITE INSTALLATION SERVICE
 AFTER SALES SUPPORT

